

Instructions for wear checks of play equipment

Playground.....

Date of installation

Checks depend on the type of equipment. Any equipment with moving parts must be checked at least twice a year, static equipment at least once a year.

Intervals for maintenance work and checks generally depend on

- location
- usage
- frequency of use
- possible vandalism

For more details see also our general instructions for maintenance of playgrounds!

Crank Handle Pump
drinking water up to underside of piston
Order No. 5.17637 / 5.17638

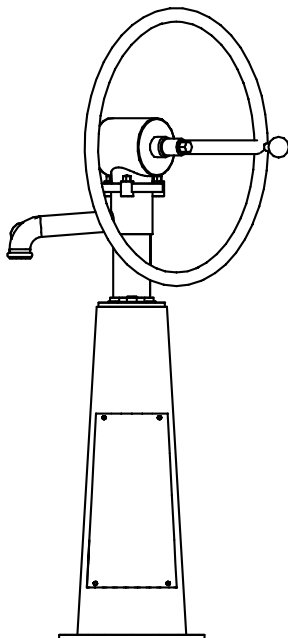

For spare parts refer to page 4.

Long-term decommissioning

Pay attention to the following notes regarding long-term decommissioning, e.g. during the winter:

Drain supply lines. Where temperatures may fall below freezing, it is imperative the pump (**No. 5.17637**) including pillar be drained. If a programmable rinsing device (**No. 5.17638**) is fitted, the time switch is particularly vulnerable to frost damage as it cannot be drained. Therefore, it is imperative the pump be dismantled. Store the pump protected from frost.

Short-term decommissioning

Pay attention to the following notes regarding short-term decommissioning:

Remove pump handwheel or secure it with a chain.

Important!

Under no circumstances simply disconnect from water supply since during dry operation the pump is exposed to extreme wear and tear. In addition, the equipment would be vulnerable to vandalism. If the relief valve is defective, the handwheel may jerk unexpectedly (risk of injury).

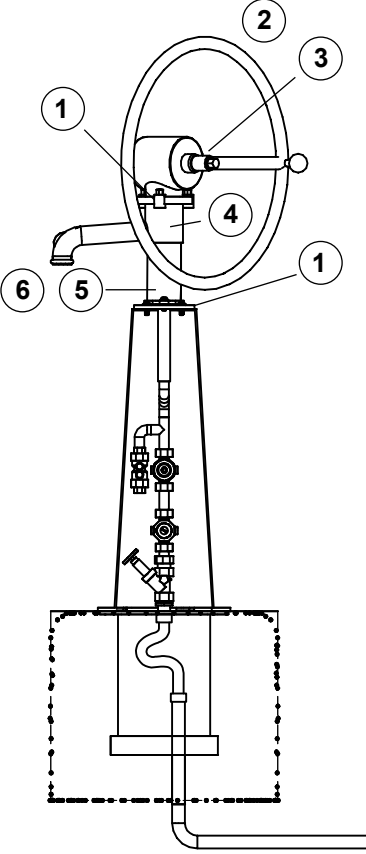
Instructions for wear checks of play equipment	The equipment must be checked for correct operation and safety, especially the points listed below:	Proof of maintenance	
	<div style="border: 1px solid black; padding: 5px; margin-bottom: 10px;"> Top part of the pump </div> <ol style="list-style-type: none"> 1. Check that all bolts are tight (2.5 Nm max.). 2. Check that handwheel moves smoothly and is securely connected; retighten nuts if necessary. 3. Check shaft bearing for wear and tear and grease using existing lubricating nipple. Replace brass bearing, if necessary. 4. Check that the bolts used to fasten the piston rod are tight. 5. Check brass sleeve and plastic piston for wear and tear. 6. Regrease grooved ring of the plastic piston using appropriate valve grease, replace if necessary. 	<input type="checkbox"/> <input type="checkbox"/> <input type="checkbox"/> <input type="checkbox"/> <input type="checkbox"/> <input type="checkbox"/>	Special notes, e.g. for repairs
	Repair not carried out, it is still possible to play on equipment	<input type="checkbox"/>	
	Repair not carried out, equipment is taken out of action	<input type="checkbox"/>	
	All work carried out, everything is in order	<input type="checkbox"/>	
Maintenance carried out by: Date			

Instructions for wear checks of play equipment

The equipment must be checked for correct operation and safety, especially the points listed below:

Proof of maintenance

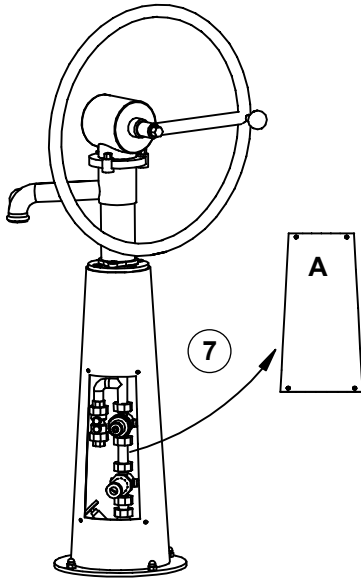

Valve combination

7. Open **service lid A** and close shut-off valve in the pillar; clean sieves in the pressure reduction valve every 6 months, clean membrane valve and safety valve if soiled, clean monthly if water is very calcareous.
8. If the pump is dripping continuously, disassemble membrane valve completely, clean sieve and valve seat (rubber flat gasket) and re-assemble. Check once again. If it is still dripping, the membrane valve unit must be replaced.
9. Check all screw fittings for leakages.
10. Check the relief valve for leakages and proper operation by closing the shut-off valve and pumping vigorously – it should be possible to hear clear sucking sounds. The pump swive should not strike back. If it does, replace the functional part within the relief valve. To do this, loosen **cap nut B**, remove the relief valve (10), loosen **cap nut C** and remove the sinter metal filter. Push the functional part out of the housing (push in the **direction C to B**). Install repair set for the functional part in reverse order. Check relief valve for proper operation as described above.
11. The sinter metal filter on the relief valve must be replaced once a year; to do this, loosen **cap nut C**, remove filter and screw in a new filter.
12. Check pressure reducer; it must be set to 1 – 1/2 bar.

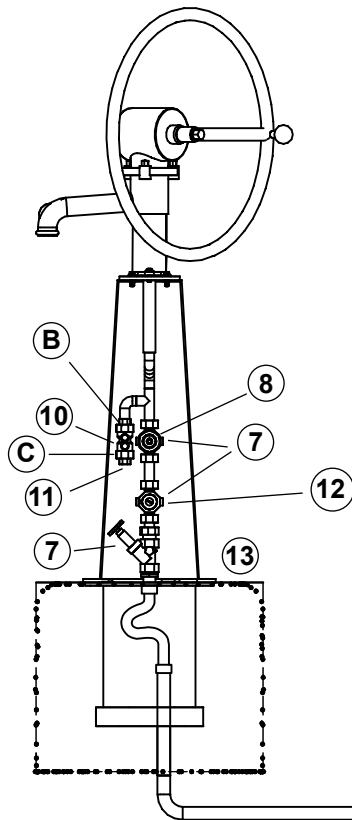

Structural stability

13. Check pump for stability.

Special notes, e.g. for repairs

Repair not carried out, it is still possible to play on equipment

Repair not carried out, equipment is taken out of action

All work carried out, everything is in order











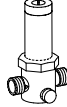

Maintenance carried out by:

..... Date

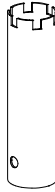
**Spare parts
Playground Pump
Order No. 5.17637 / 5.17638**

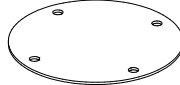

Please note that the safety standards of the equipment must not be affected. Therefore, when carrying out repairs it is helpful to **only use original parts**.

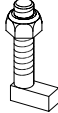
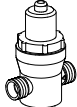
Order No.	Spare parts	Order No.	Spare parts
0.97806	Outlet sieve 	0.97822	Cartridge for membrane valve * 
0.97807	Relief valve 	0.97830	Pressure reducer 
0.97808	Sinter metal filter * 	0.97862	Hose clip 
0.97809	Repair kit for relief valve * 	0.97818	Tool for opening the membrane valve 
0.97730	Piston from POM, incl. 1 tube 	0.97824	Front gripping pliers for replacing the cartridge of the membrane valve
0.97727	Retaining ring for plastic piston 	0.97815	Repair Kit <i>(contains all parts marked with *)</i>
0.97728	Grooved ring for plastic piston incl. 1 tube of fitting grease 	5.17634	Winter lid 
0.97770	Rubber seal for mounting plate * 		
0.97780	Rubber seal with air dome cap * 		
0.97810	Stainless steel hook bolt with nut 		
0.97820	Membrane valve – new 		

LudoCrea.ch GmbH — 6074 Giswil — +41 41 675 03 67 — info@ludocrea.ch